

Bus Power Supply, 48V Installation Guide



Introduction

The Control4® Bus Power Supply (C4-DIN-BPS48) is intended for use in a Control4 system. This device installs in a Control4 Centralized Lighting panel or in any standard DIN rail panel with 35 mm rails. The Bus Power Supply provides the power to the Bus Ethernet Gateway (C4-DIN-BEG) and Control4 wired keypads (C4-KCB-xx and C4-SKCB-xx) in a Centralized Lighting system.

Package contents

- Bus Power Supply
- Pluggable Terminal Block (1)
- *Bus Power Supply Installation Guide* (this document)

Warnings and considerations

- Warning!** Improper use or installation can cause SERIOUS INJURY, DEATH or LOSS/DAMAGE OF PROPERTY.
- Attention !** Une mauvaise utilisation ou installation peut entraîner des blessures graves, décès ou perte / dommages à la propriété.
- Warning!** This device must be protected by a circuit breaker (20A max).
- Attention !** Cet appareil doit être protégé par un disjoncteur (20A max.)
- Warning!** Disconnect the power for all lines feeding into the panel before installing this product.
- Attention !** Couper le courant électrique pour tous les disjoncteurs d'alimentation dans le panneau avant d'installer ce produit.
- Important!** The Bus Power Supply should be installed by a licensed electrician in accordance with all national and local electrical codes.

Requirements and specifications

Before installing this product, make sure that the Control4 5-Slot or 2-Slot Panel (or other cabinet) to house the power supply has been installed.

Part number	C4-DIN-BPS48
Power input	100-277VAC / 1.25A
Power output	48V DC 1.2A (120-277V) 48V DC 1.0A (100-120V)
Power consumption	75W, 120V/1.0A; 277V/0.6A
Connectors	One RS-485 Pluggable Terminal Block 36 AWG to 14 AWG (0.14 mm to 1.5 mm) One Line Voltage Screw Terminal • One Line • One Neutral • One Earth Ground • One 26 AWG to 12 AWG (0.12 mm to 4 mm)
Operating temperature	0 to 40 °C (32 to 104 °F)
Humidity	5% - 95% Non-condensing
Storage	-20 to 70 °C (-4 to 158 °F)
Dimensions	107.5 × 113.9 × 59 mm (4.23 × 4.48 × 2.32 in.)
DIN module width	6M
Weight	0.589 kg (1.3 lb.)
Shipping weight	0.770 kg (1.7 lb.)

Front view



Figure 1: Front view

- A** Pluggable terminal connector
- B** Power LED
- C** Line voltage connector

Preparing to install

Before you install in a Control4 panel:

- 1 Use Composer Pro to add the Bus Power Supply to a project, define its location in a panel, and print the Panel Report. See the *Composer Pro User Guide* for details.
- 2 Install the panel following the instructions in the *5-Slot and 2-Slot Panel Installation Guide*.
- 3 Install and wire the Terminal Block for the Bus Power Supply following the instructions in the *Terminal Block Installation Guide* and in the location defined by the Composer Pro panel reports.

 **Note:** Third-party panels do not require a Terminal Block.

Before you install into a third-party DIN rail panel:

- 1 Install the third-party panel according to the third-party instructions.

Installing the power supply

To install the power supply into a Control4 panel:

- 1 With the pluggable terminal connector facing right, hold the power supply upright and angle it to the right so that the right side of the module fits onto the rail in the panel.
- 2 With the right side already in place, press forward on the left side of the Bus Power Supply to snap it onto the rail (see *Figure 2*).

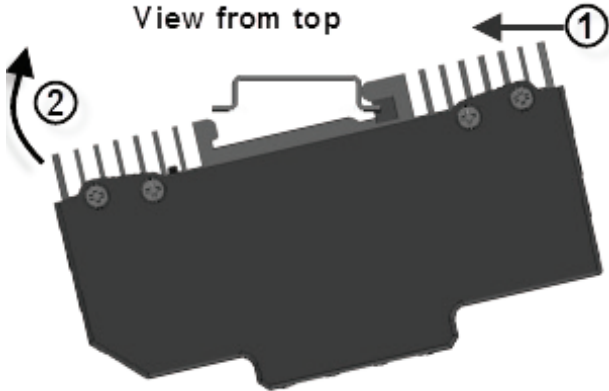



Figure 2: Snap on the Bus Power Supply - Control4 panels

 **Note:** To remove the module, press the module toward the bottom, rotate the module up, and lift it off.

To install the power supply into a third-party panel:

- 1 With the pluggable terminal connector facing up, hold the power supply lengthwise and angle it up so that the top side of the module fits onto the rail.
- 2 With the top side already in place, rotate the power supply down to snap it onto the rail (see *Figure 3*).

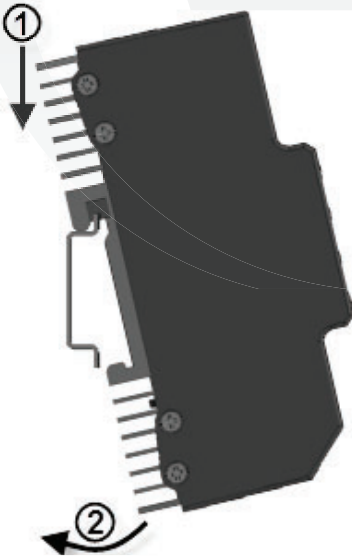



Figure 3: Snap on the Bus Power Supply—third-party panels

 **Note:** To remove the module, press the module toward the bottom, rotate the module up, and lift it off.

- 3 Install the other modules into the panel as defined in their respective installation guides.

Wiring instructions

See *Figure 4* on the next page to view the wiring diagram. Read the *Keypad Bus Wiring Guide* (ctrl4.co/buswiring) for full wiring details.

 **Warning!** When wiring the RS-485 Pluggable Terminal Connector, make sure that either the Line level power is OFF or that the connector is not connected.

 **Important:** All wires between the Pluggable Terminal Block and the Bus Power Supply must use the same gauge wire as the field wiring connected to the Pluggable Terminal Block.

 **Note:** Wiring between the Pluggable Terminal Blocks and the module will be easiest when stranded wire is used.

- At the Terminal Block side, strip the wires 0.35" (9 mm) and tighten to 7 in-lb (0.8Nm).
- At the module side, strip the wires 0.3" (7 mm) and tighten to 5.3 in-lb (0.6Nm).

← To Keypads
 (Max 40 Keypads, Max 1000 ft / 304 m)
 (Max 35 Keypads when running at 100VAC input)

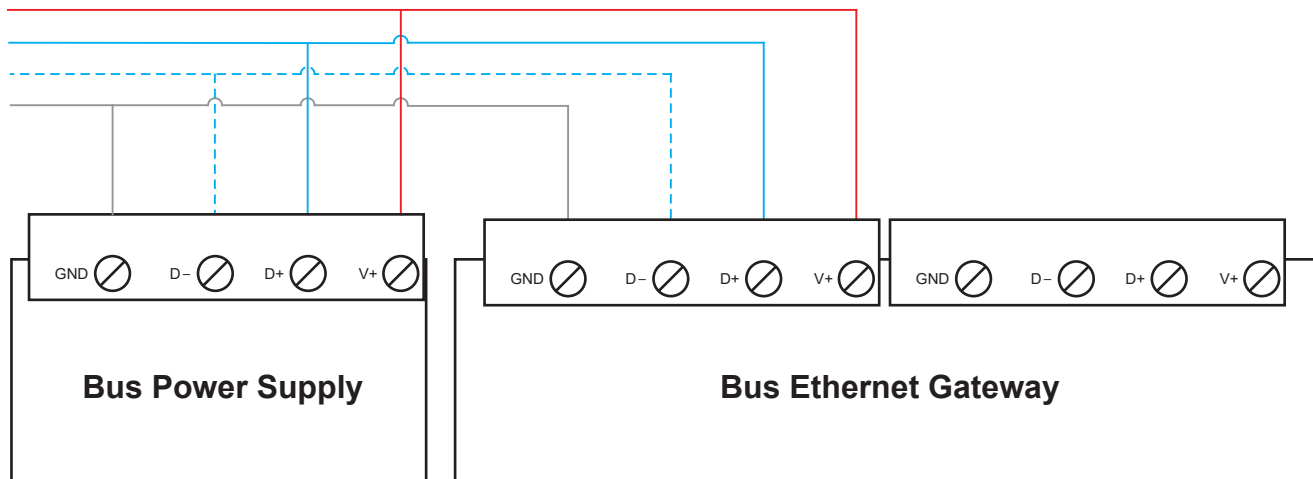

Figure 4: Bus Power Supply wiring diagram

LED indicators

The indicator lights on the front of the Bus Power Supply communicate the status of the device.

Indicator	Color	Status
Power	Blue	Device is on
	Black	Device is off
Status	Red	Red means voltage below 36V (too many keypads)
	Flashing red	Flashing red means overload or short circuit

Troubleshooting

Symptom	Possible solution
Module does not power on.	Make sure the module is connected securely to the Mains power supply.

Additional resources

The following resources are available for additional support:

- Control4 Knowledgebase and forums
- Control4 Technical Support
- Control4 website: www.control4.com
- Composer documentation available at ctrl4.co/docs.

For the latest version of this document, open these URLs or scan the QR code on a device that can view PDFs.

Regulatory/Safety information

To review Regulatory information for your particular Control4 products, see the information located on the Control4 website at ctrl4.co/reg.

Patent information

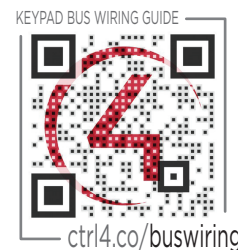
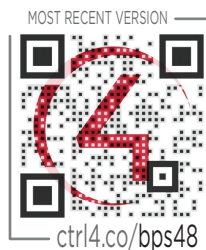

Applicable patents are available at ctrl4.co/patents.

Warranty

Visit ctrl4.co/warranty for details.



Control4[®]

control4.com | 888.400.4070

Copyright ©2020, Wirepath Home Systems, LLC. All rights reserved. Control4 and Snap AV and their respective logos are registered trademarks or trademarks of Wirepath Home Systems, LLC, dba "Control4" and/or dba "SnapAV" in the United States and/or other countries. Snap AV and Wirepath are also registered trademarks or trademarks of Wirepath Home Systems, LLC. Other names and brands may be claimed as the property of their respective owners. All specifications subject to change without notice.

E
200-00371-E
2020-02-03 MS